



Profipress-Schiebemuffe mit SC-Contur

- Pressanschlüsse

Ausstattung

Dichtelemente EPDM

Modell 2415.3

Artikel 461 256

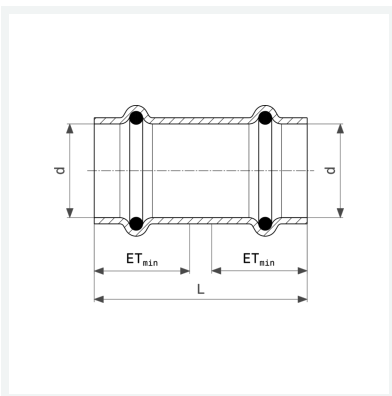

Eigenschaften

Rohraußendurchmesser	d	15
Länge	L	47 mm
Einstecktiefe minimal	ETmin	22 mm
Gewicht	34 g	
Volumen	62,16 cm ³	
Werkstoff	Kupfer	