

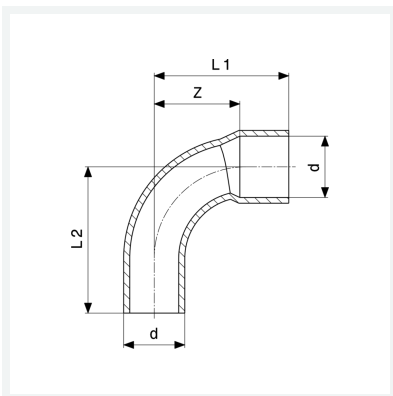

Bogen 90°
- Lötanschluss, Einsteckende
Modell 95001A

Artikel 101 510



Eigenschaften

Gütesicherung Cu	Cu	✓
Rohraußendurchmesser	d	12
Z-Maß	Z	14 mm
Länge 1	L1	23 mm
Länge 2	L2	25 mm
Gewicht	11,24 g	
Volumen	16,576 cm ³	
Werkstoff	Kupfer	